



AERO SPACE POWER

CERTIFIED MRO SHOP

Company Introduction





AERO SPACE POWER

CERTIFIED MRO SHOP

VISION

OUR VISION IS TO BECOME THE LEADING HIGH-TECH MANUFACTURER AND SERVICE PROVIDER IN THE REGION.

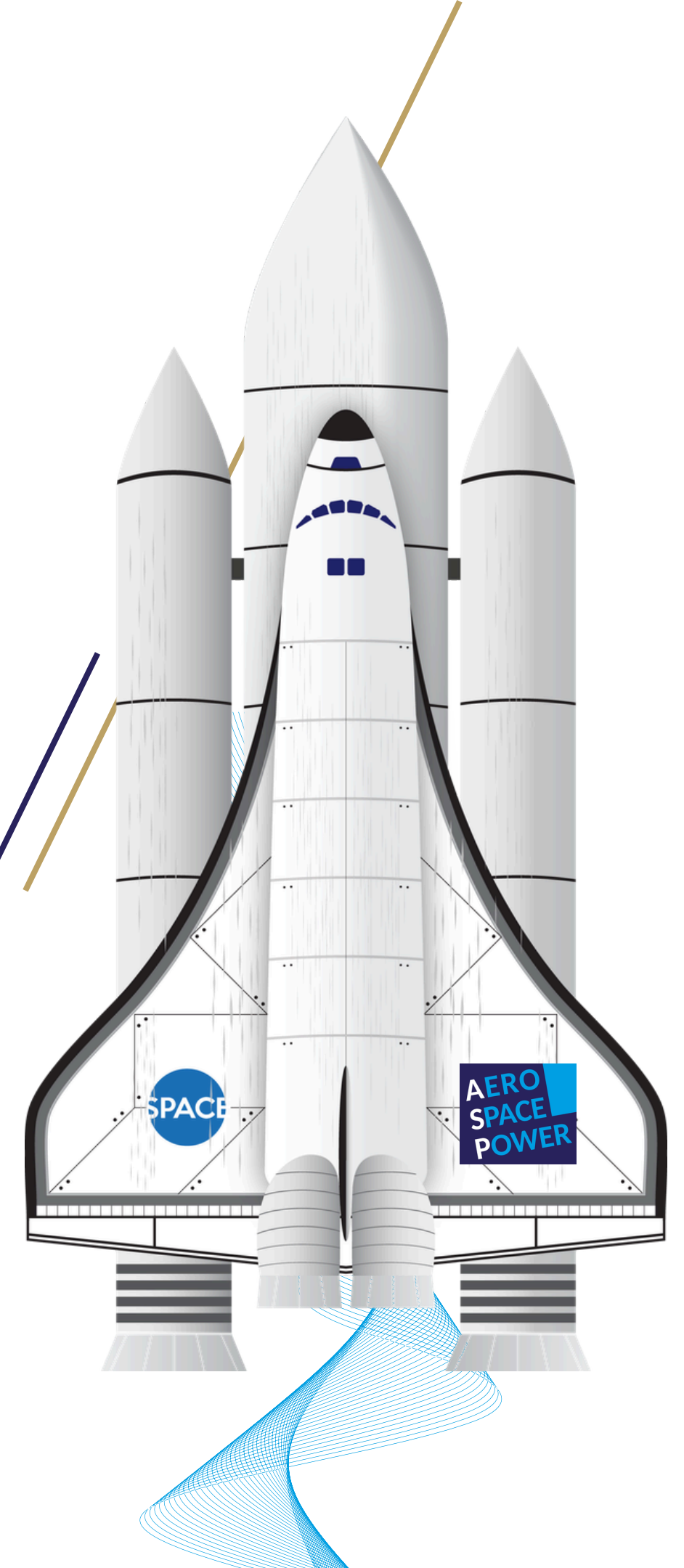



AERO SPACE POWER

CERTIFIED MRO SHOP

AERO SPACE POWER Profile Powered by Xanga Ventures



AERO SPACE POWER

CERTIFIED MRO SHOP



AERO SPACE POWER Profile

Revenue:	\$26 MM
Founded:	2021
Sales:	+35% YoY
Employees:	240
Locations:	3

Portfolio

AVIATION



INDUSTRIAL GAS TURBINES



AERODERIVATIVE

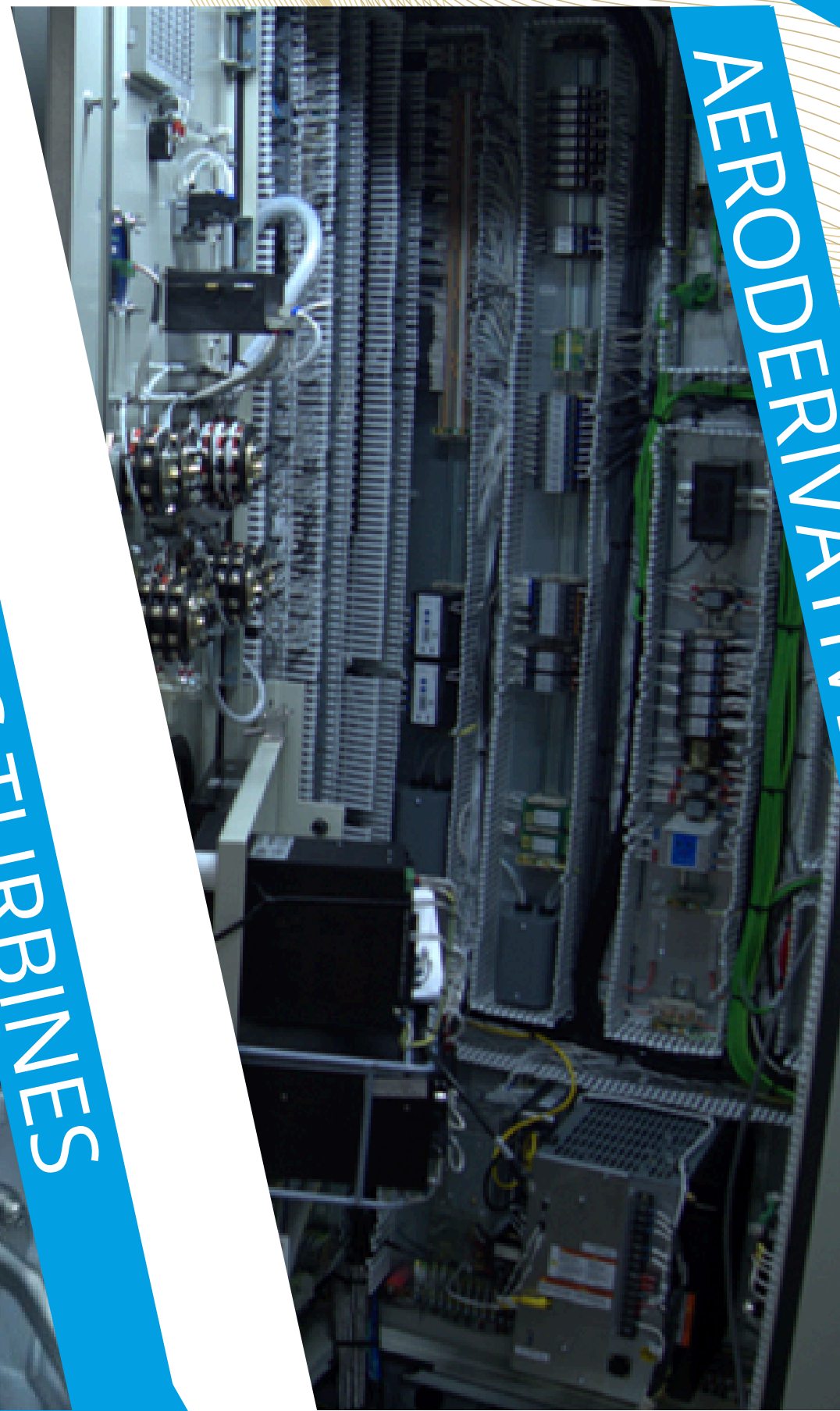

Corporate Values



**Continuous
Improvement**



Endurance



Partnership



Integrity



Customer Focused Mindset



Seeking breakthrough each day



We are ready to perform to the highest standards



Fairness with partners is essential



We work for the benefit of our customers



We create value together
“Teamwork makes the dream work”

Certifications





AERO SPACE POWER

CERTIFIED MRO SHOP

EUROPE

HUNGARY

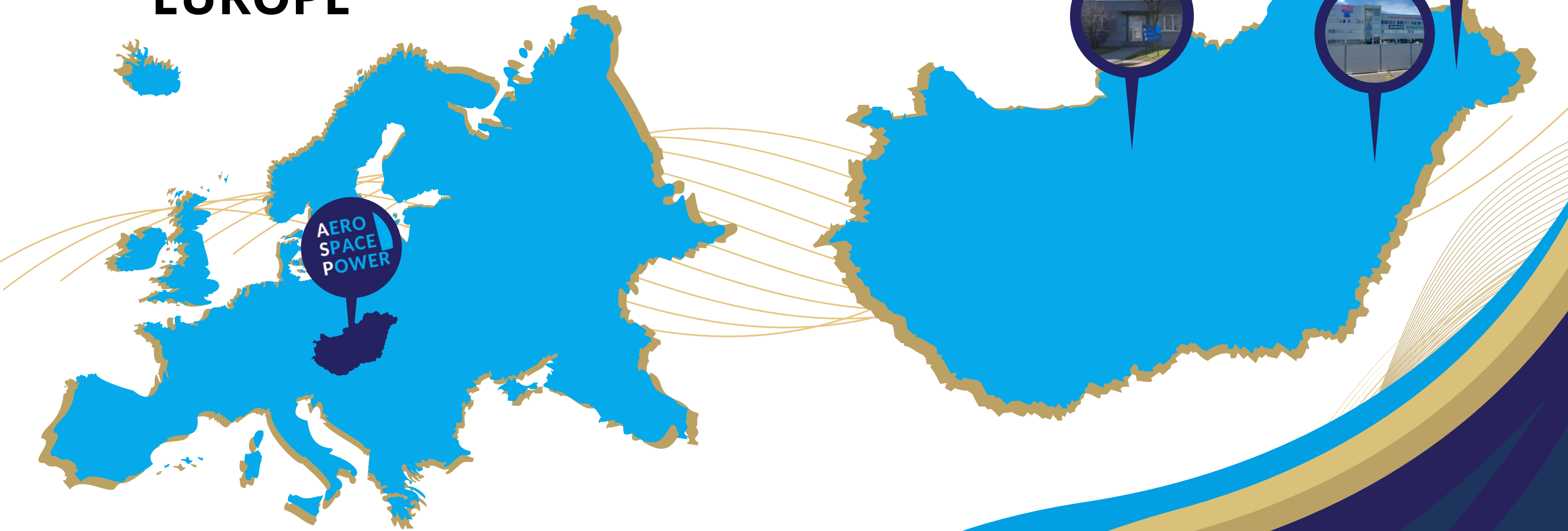

Kisvárdá

- Certified MRO Shop
- Aviation Part 145
- Power Repair Certified
- Control Systems
- Welding Shop



Budapest

- Sales Office
- Welding Shop
- Engineering Office



Debrecen

- Base Maintenance
- Engineering Office



Facts and Figures

Aviation



15 670 pcs Repairs / year
7 – 21 days TAT

Power



**12 164 pcs Repaired
Parts/year**

Control System



**130 pcs Electrical Cabinet
Assembled / year**

Welding Shop

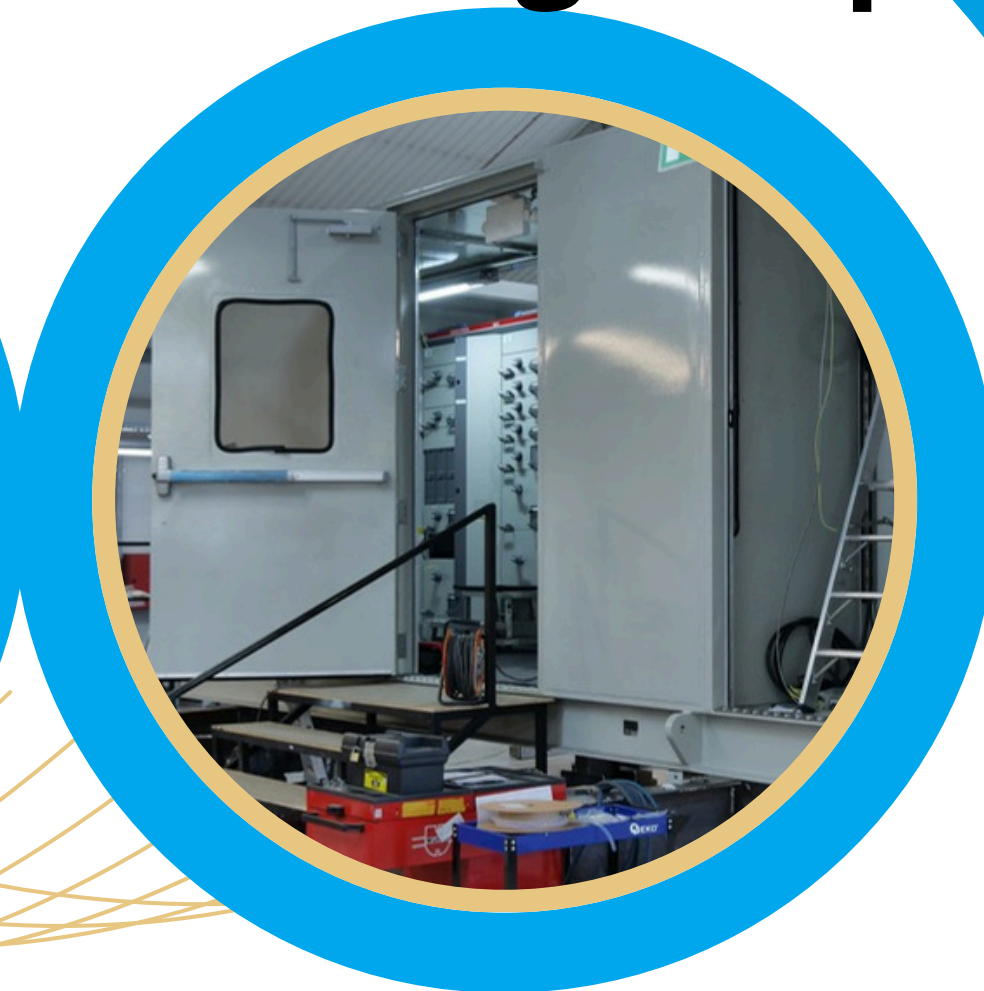

**24 pcs Welded
Structure / year**

Customers

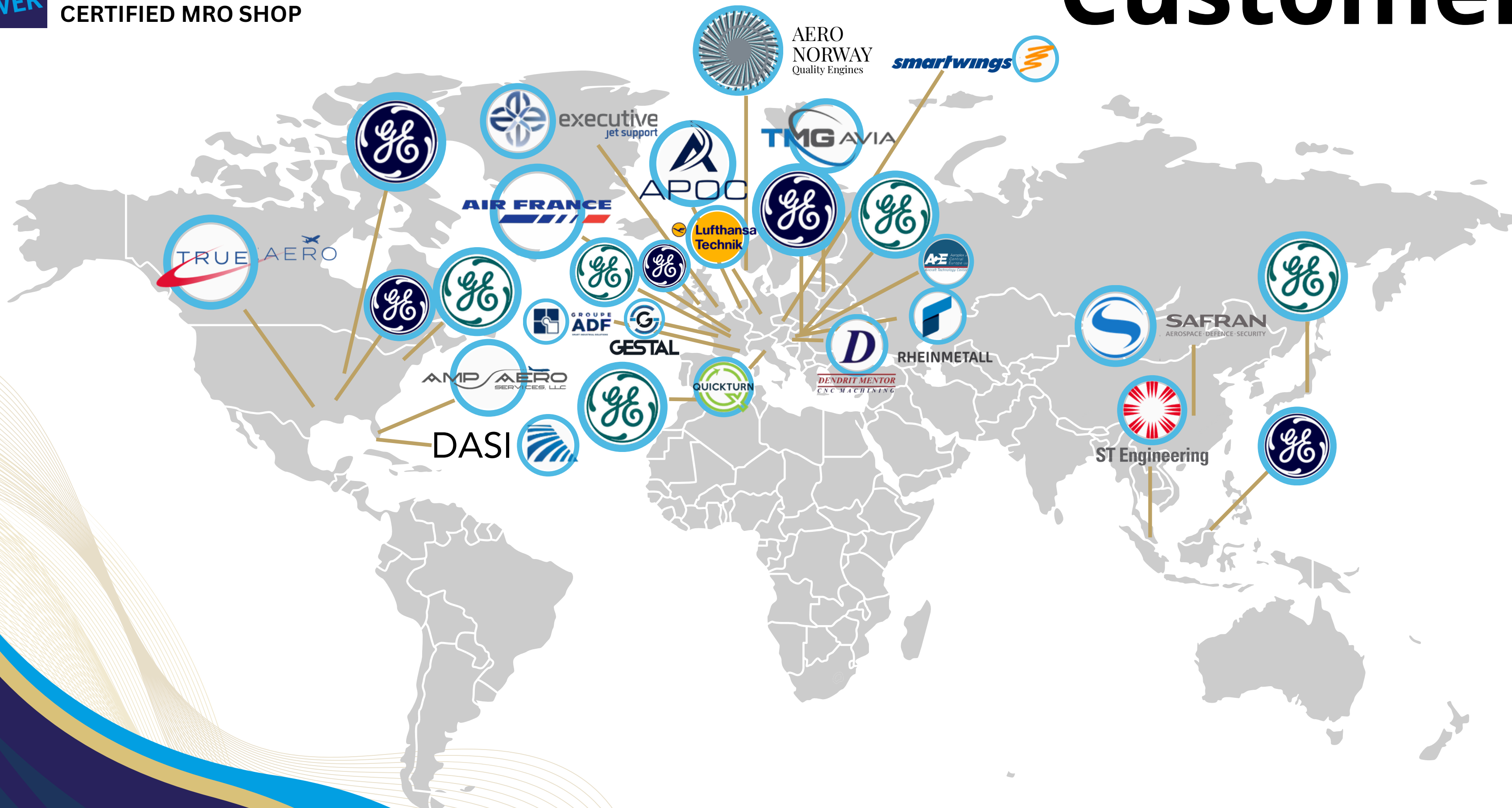



AERO SPACE POWER

CERTIFIED MRO SHOP



Aviation

CFM56-5B / 7B



CF34-10E

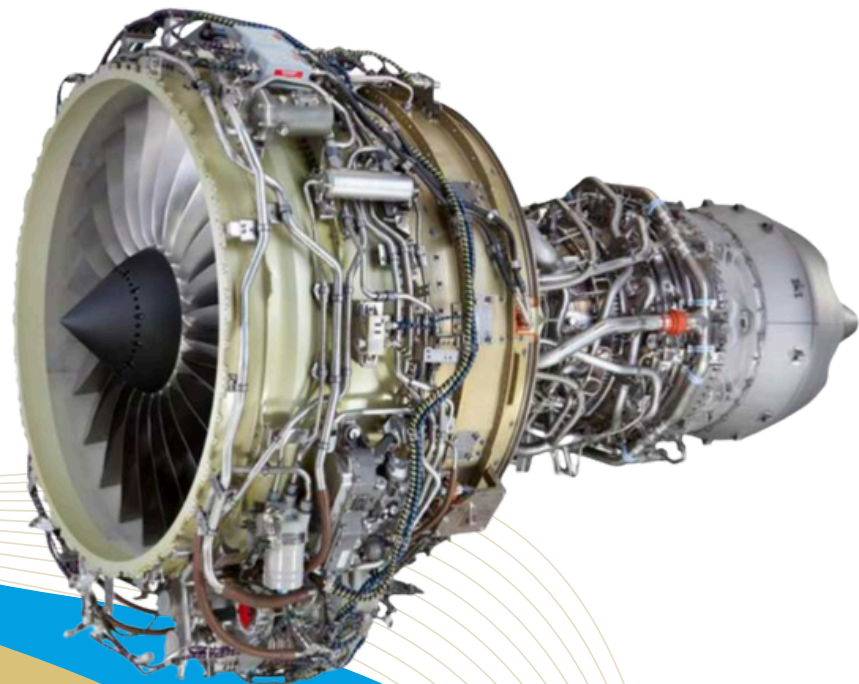

GE90-94B / 115B

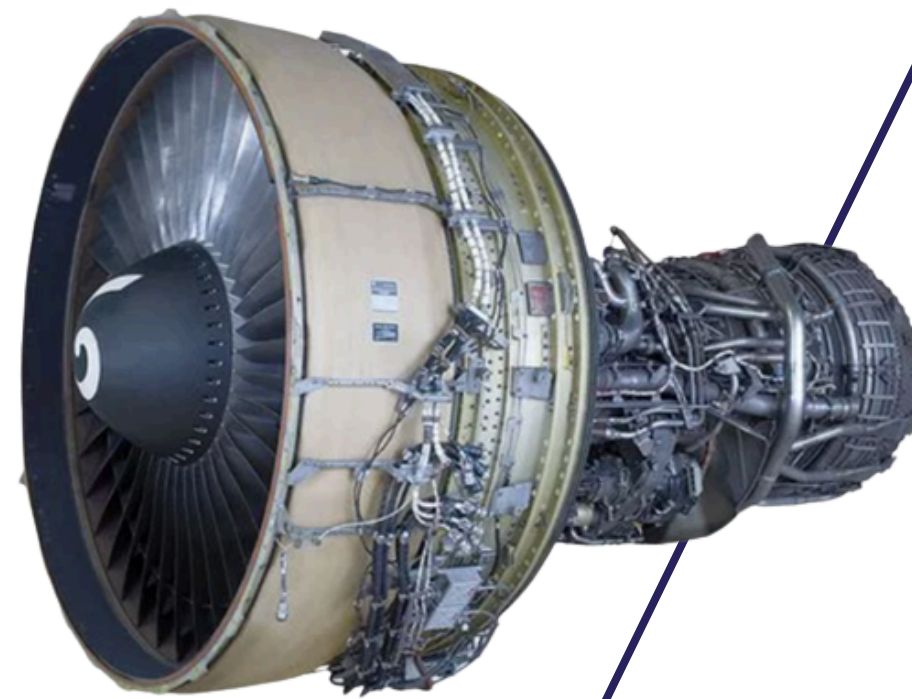

CF6-80C2 / E1





AERO SPACE POWER

CERTIFIED MRO SHOP

Aviation Capabilities

Avg TAT: 17 days

Avg Yield: 92%

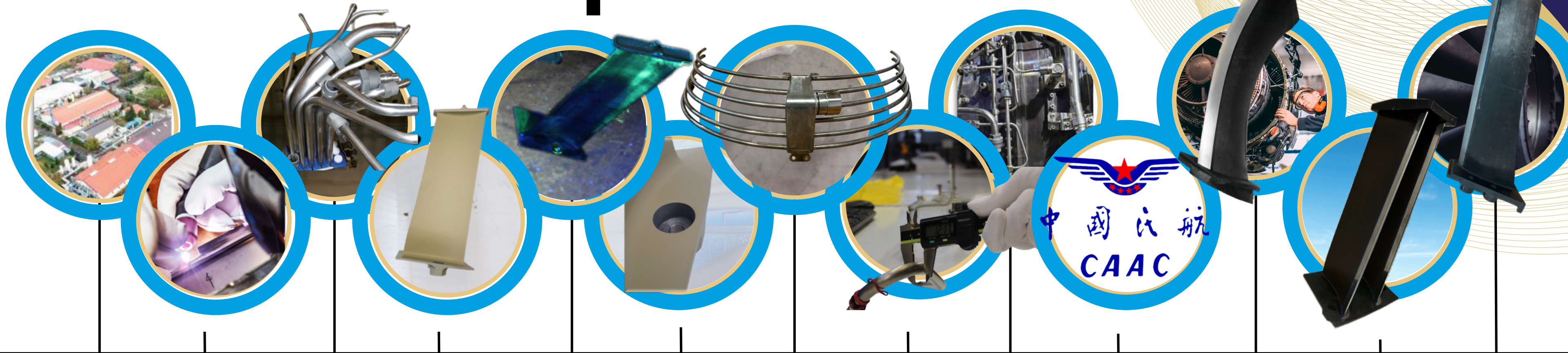

2018

EASA/FAA Part-145 Certified Engine Component Repair Shop

2018

HC Repair
GE90-94B
GE90-115B
CF6-80C2

2019

Tubes Ducts & Manifold Overhaul
CFM56-5B/7B
GE90-94B
GE90-115B

2021

FAN OGV Repair
CFM56-7B

2023

FAN OGV Overhaul
CFM56-7B

2024

FAN OGV Rep013
CFM56-7B

2025

LPT Cooling Manifold Overhaul
CFM56-5B/7B

2025

Tubes Ducts & Manifold Overhaul
CF34-10E

2025

Tubes Ducts & Manifold Overhaul
GE90-115B

2025

CAAC part-145 certified engine component repair shop

2025

FAN OGV Overhaul
CF34-10E

2025

FAN OGV Overhaul
CFM56-5B

2025

FAN OGV Composite
CF6-80C2

INDUSTRIAL GAS TURBINES



Frame 6

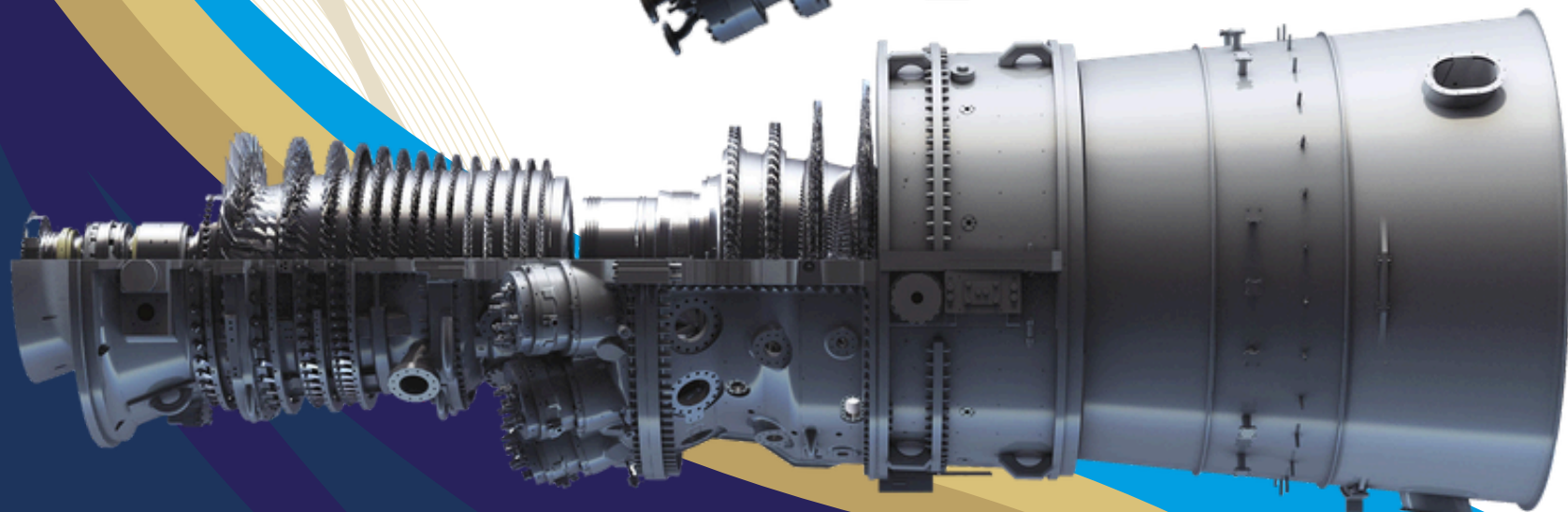

Frame 7

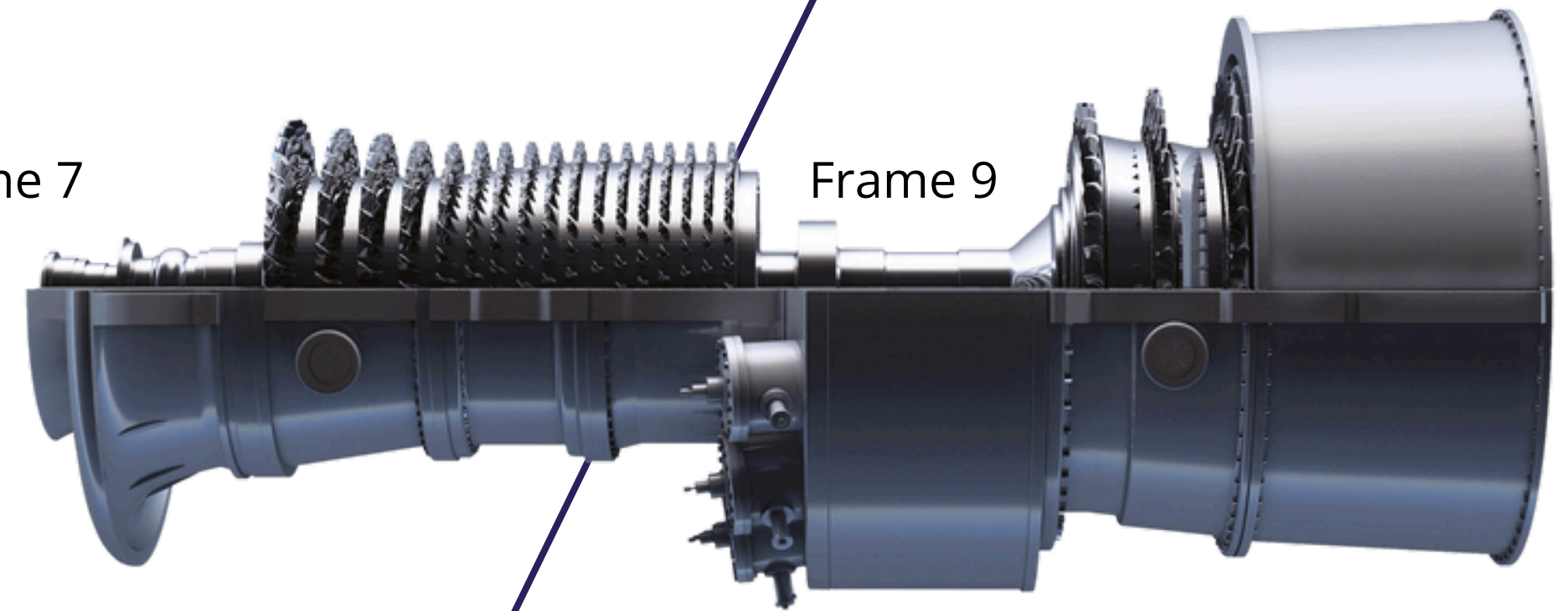

Frame 9

IGT Capabilities

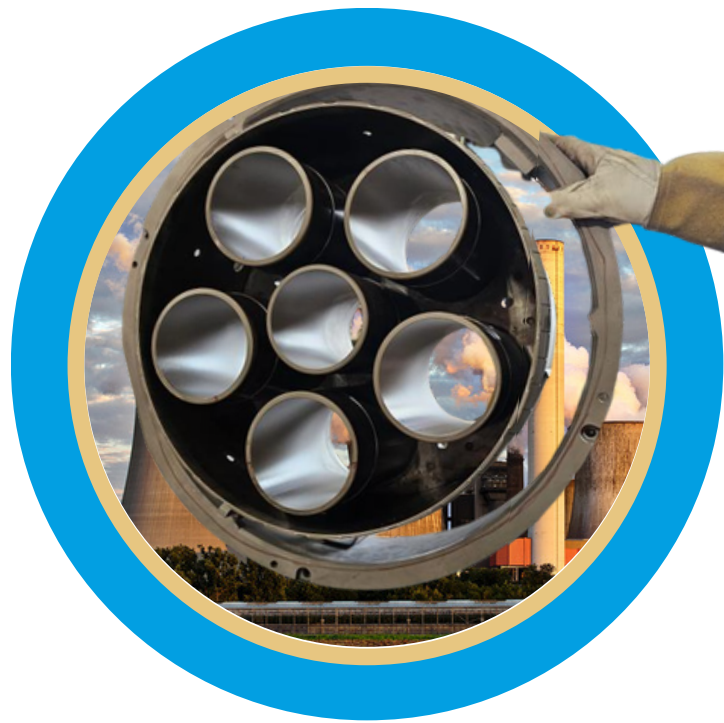

COMBUSTION
CAP REPAIR



COMBUSTION LINER
REPAIR



TRANSITION
PIECE REPAIR

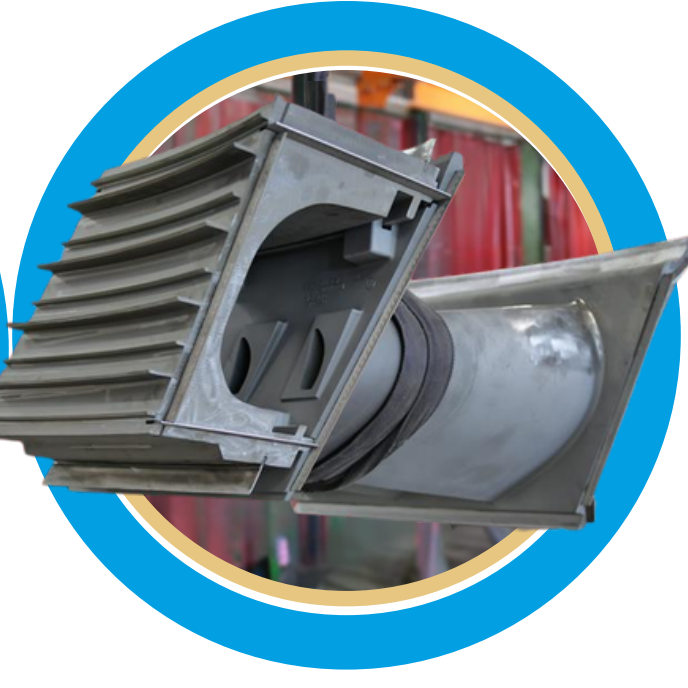

HOT GAS PATH
NOZZLE REPAIR



New make
components

All types of GE's heavy duty frames 6-7-9



AERO SPACE POWER

CERTIFIED MRO SHOP

AERODERIVATIVE SOLUTIONS

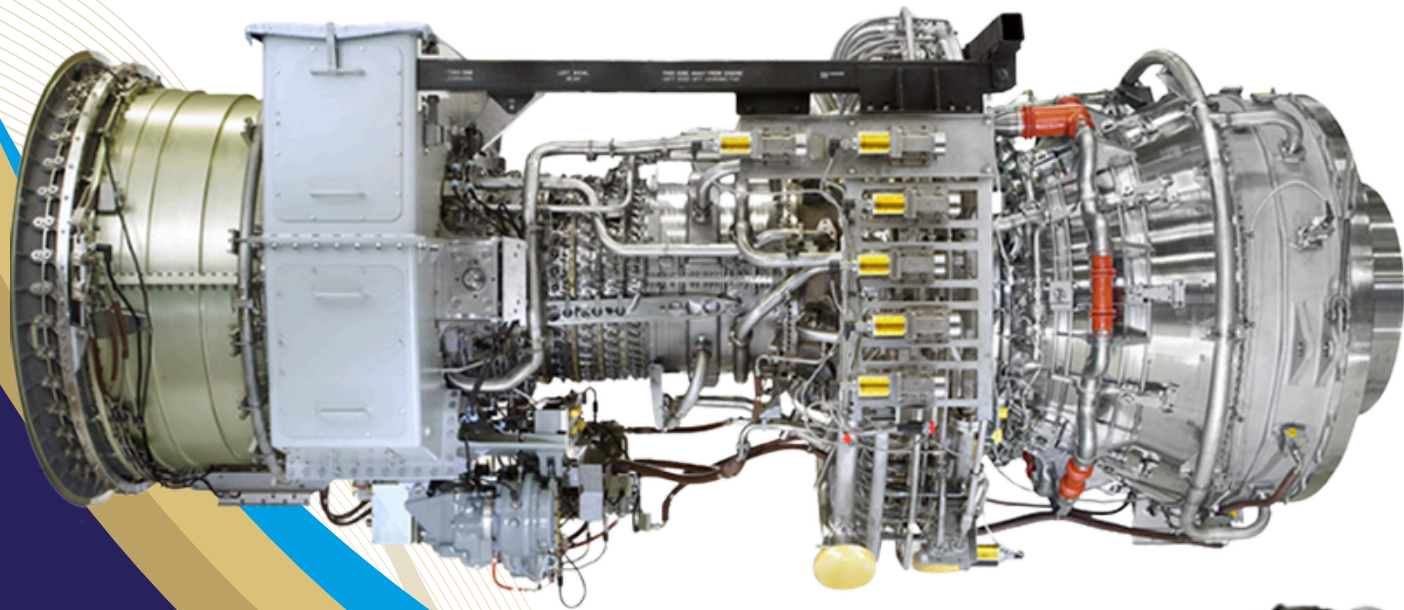

LM6000

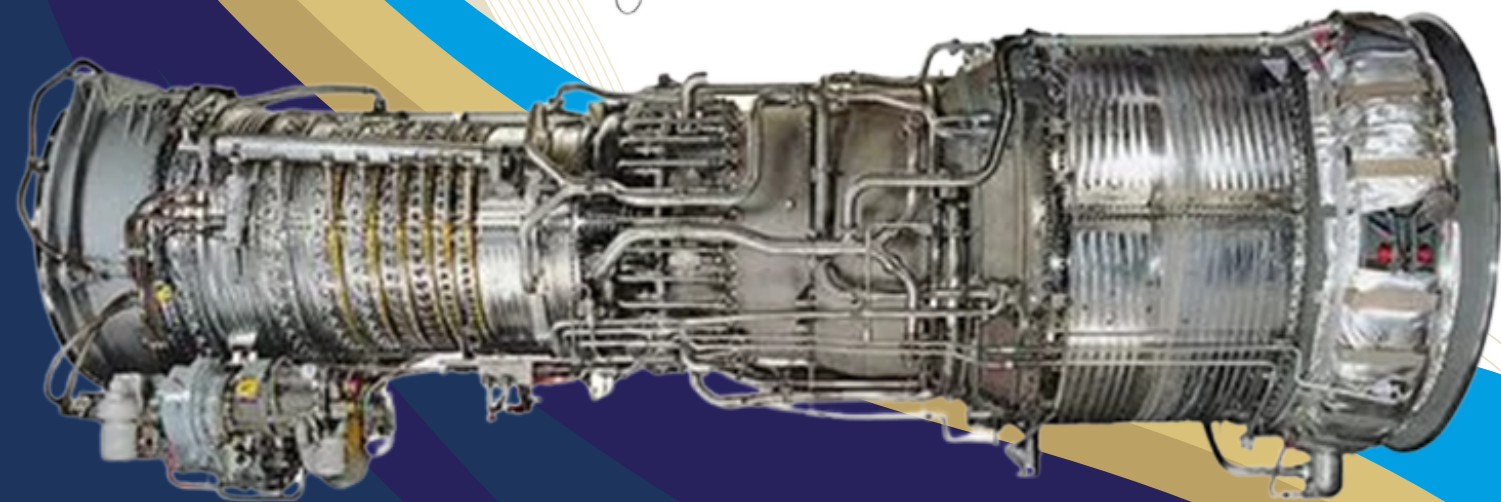

LMX/LM2500



Aeroderivative Capabilities

- **LM 2500 Control House Production and Assembly**



- **LM 2500/6000 Cabinet Assembly**





HEADQUARTER: HUNGARY, 4600 KISVÁRDA, TEMESVÁRI U. 17.



SALES OFFICE: HUNGARY, 1158 BUDAPEST, HŰTŐ U. 1.



ENG. OFFICE: HUNGARY, 4030 DEBRECEN, REPÜLŐTÉRI ÚT 12.



Web Page



LinkedIn



X



The145.com